

TIY Programmable Isolated Thermocouple Transmitter



Table of Contents

Introduction	3
Description	3
Specifications.....	4
Ordering Information.....	5
Options	5
TIY Model Numbers.....	7
Calibration	7
Setting the Configuration Jumpers	8
Calculating the TIY's Accuracy	10
LCD Readings	11
Standard and Quick Ranging.....	11
Standard Ranging	12
Quick Ranging.....	14
Installation	17
Mounting the TIY.....	17
HP Housing.....	17
DIN Housing.....	17
Making the Electrical Connections.....	18
Operation	19
The LCD	19
Maintenance	20
Customer Support	20

Introduction

Moore Industries' Programmable Isolated Thermocouple Transmitter (TIY) is a 2-wire, microprocessor-based instrument that converts thermocouple or millivolt input into 4-20 mA output. The output is field-configurable to be linear with temperature or millivolt input.

The highly accurate TIY features easy-to-use membrane push buttons (referred to as "push buttons" in the manual) and solderless jumpers for easy field calibration and configuration.

This manual contains the information necessary to calibrate, install, operate, maintain, and troubleshoot the TIY. It includes a brief unit description, a table of performance and operational specifications, and an explanation of Moore Industries' model/serial number-based product data tracking system.

The following guidelines are used throughout the manual:

WARNING – Hazardous procedure or condition that could injure the operator.

Caution – Hazardous procedure or condition that could damage or destroy the unit.

Note – Information that is helpful for a procedure, condition, or operation of the unit.

Description

The TIY is a loop-powered, thermocouple transmitter that accepts input from standard ISA thermocouples (types J, K, E, T, R, S, or N) or a millivolt source, and produces proportional 4-20 mA output.

Front panel push buttons set zero and span (full-scale) values. These values remain until they are changed by the user.

An LCD provides readouts of the applied input (either in temperature or millivolts), displays problem codes, and is used for quick ranging.

Several functions of the TIY are configured with solderless jumpers. Each of these jumpers is accessible without disassembling the unit. The jumper-selectable features include:

- Reference junction compensation/no reference junction compensation
- Degrees Fahrenheit/Celsius
- Upscale/downscale burnout
- Linearization/no linearization of the output
- Quick/standard ranging

The TIY is available in two housing styles: Hockey-puck (HP) and DIN-style. The TIY's application will determine which housing style is suitable.

The HP-style housing is equipped with spring clips for mounting in an explosion-proof enclosure. The TIY packaged in an HP-style housing and equipped with flange plates (FL housing option) is designed to mount on a flat surface or on relay tracks (refer to the Installation Section). The all-aluminum DIN-style housing snaps directly onto standard G-type or Top Hat rail.

The performance and operational specifications for the TIY are next. Refer to the Installation Section for the outline dimensions of both housing styles and to the Calibration section for span accuracy information.

Specifications

<p>Performance Output Accuracy: ±0.05% of span (maximum input-to-output error is the sum of the input, output and Reference Junction Compensation accuracy values. See Table 1 for details). Ripple: Less than 10mV peak-to-peak, maximum (up to frequencies of 120Hz) measured across a 250 ohm load resistor Burnout Protection: Upscale drive is the standard factory configuration; downscale drive can be configured via a solderless jumper Operating Limits: No damage up to ±42V on input and ±60V on output Output Protection: Transient protection and reverse polarity protection Output Current Limiting: 125% of span, typical; 130% of span, maximum Load Capability: $(V_p - 12V) / 0.024A = \text{ohm}$ Common Mode Rejection: At least 120dB at 50Hz/60Hz</p>	<p>Performance (continued) Isolation: 500Vrms galvanic isolation between input and output terminals RFI/EMI protection: When tested according to SAMA Standard PMC 33.1, protection rates: <u>DIN and HP/FL Housings:</u> 10V/m-ABC² 0.1% of maximum span (for 30V/m protection on DIN housing, see the -RF option) <u>2LG and 2LS (HP housing in explosion-proof enclosure):</u> 30V/m-ABC² 0.025% of maximum span</p> <p>Ambient Temperature Operation: -40°C to +82°C (-40°F to +180°F) Momentary, recoverable dimming of display may occur at low temperatures Effect (except reference junction compensation): ±0.01% of maximum span/°C Reference Junction Compensation Effect: Reference junction compensation effect, ±0.75°C/50°C change in ambient temperature</p>	<p>Adjustments Zero and Span: Membrane push buttons. Span changes within an input range (see Range Codes in Table 1) are made with membrane push buttons; changing Range is done by changing the positions of solderless jumpers</p> <p>Indicators Type: 4-digit LCD indicates input value in °C, °F or millivolts (jumper-selectable); also indicates zero and full-scale values, problem codes and high or low table limit warnings Display Accuracy: ±0.1% of maximum span for range code, ±1 count</p> <p>Weight DIN Housing: 141 grams (5 ounces) HP Housing: 184 grams (6.5 ounces)</p>
--	---	---

Ordering Information

Unit	Input	Output	Power	Options	Housing
TIY	See Range Codes (e.g., J1, K2, N1) in Table 1	4-20MA into 600 ohms with 24Vdc power supply	12-42DC 12-30DC for Intrinsically Safe units (power supply and load effects are negligible)	<p>-DD Downscale Drive— output goes downscale within two seconds after an open input or an instrument fault is detected (Upscale or Downscale Drive is jumper-selectable)</p> <p>-DDX Direct Downscale Drive—output goes downscale on open input. Output will not exceed process value on open input or reconnection of an open input (jumper- selectable upscale/downscale drive selects action on instrument fault only when this option is specified)</p> <p>-ND No display (indicator not provided)</p> <p>-NL Configured to provide output linear with input, rather than linear with temperature (jumper-selectable)</p> <p>-RF DIN housing rates 30v/m—ABC < 0.01% of maximum span when tested according to SAMA Standard PMC 33.1</p> <p>-SP1 Low temperature range for J- and T-type thermocouples (replaces N1 and N2 Range Codes)</p> <p>-SP2 Required for B1 Range Code (replaces S1 Range Code)</p> <p>-ISC Intrinsically Safe, CSA (12-30DC power required)</p>	<p>DIN DIN-style housing mounts on G-type rail</p> <p>HP Hockey-puck housing with spring clips</p> <p>FL Hockey-puck housing with flanges for surface or relay track mounting</p> <p>BH2NG (*) or (‡) Aluminum Explosion-Proof enclosure with two 1/2-inch NPT entry ports and a glass cover</p> <p>BH2TG (*) or (‡) Aluminum Explosion-Proof enclosure with two 3/4-inch NPT entry ports and a glass cover</p> <p>BH2MG (*) or (‡) Aluminum Explosion-Proof enclosure with two M20 x 1.5 NPT entry ports and a glass cover</p> <p>BH3NG (*) or (‡) Aluminum Explosion-Proof enclosure with three 1/2-inch NPT entry ports</p> <p>BH3TG (*) or (‡) Aluminum Explosion-Proof enclosure with two 3/4-inch side-entry NPT ports, one 1/2" bottom port, and a glass cover</p> <p>BH3MG (*) or (‡) Aluminum Explosion-Proof enclosure with two M20 x 1.5 side-entry ports, one 1/2" bottom-entry port, and a glass cover</p> <p>SB2NG (*) or (‡) 316 Stainless Steel 2-Hub, Explosion-Proof enclosure with two, 1/2 inch NPT entry ports and a glass cover</p> <p>SB2MG (*) or (‡) 316 Stainless Steel 2-Hub, Explosion-Proof enclosure with two, M20 x 1.5 entry ports and a glass cover</p> <p><i>*Either A or E suffix (comes supplied with 2" pipe mount hardware)</i></p> <p>A suffix indicates ANZEx/TestSafe (Ex d) Flameproof approvals (i.e. BH2MGA)</p> <p>E suffix indicates ATEX (Ex d and tD) Flameproof approvals (i.e. BH2MGE)</p> <p>‡ P suffix indicates enclosure comes equipped with base plate and U-bolts for mounting on a 2-inch pipe (i.e. BH2NGP)</p> <p>See BH and SB Datasheets for additional information.</p>

Options

The TIY is available with the following options:

CE Option – (HP housing only) - CE approval.

DD Option – Downscale Drive. Output goes downscale within two seconds after open input or instrument fault is detected. (Upscale or Downscale drive is jumper-selectable).

DDX Option – Downscale Drive. Output goes downscale on open input. Output will not exceed process value on open input or reconnection of an open input.

ISC Option – (HP housing only) - Intrinsically Safe, CSA (12-30DC power required).

ND Option – No display (LCD).

NL Option – Configured to provide output linear with input, rather than linear with temperature (jumper-selectable).

SP1 Option – Temperature range for J- and T-type thermocouples (replaces N1 and N2 Range Codes)

SP2 Option – Required for B1 Range Code (replaces S1 Range code)

For availability of other options, contact your local Moore Industries' Sales Representative.

Table 1. Range Limits and Accuracy for the TIY with Thermocouple Input

Input Type	Range Code	Lower ¹ (= to 4mA)	Maximum Zero	Upper ² (= to 20mA)	Input	Output ³	Reference Junction Compensation
J	J1	-50°C (-58°F)	375°C (707°F)	450°C (842°F)	±0.08°C (±0.14°F)	±0.05% of span	±0.25°C (±0.45°F)
	J2	-50°C (-58°F)	560°C (1040°F)	760°C (1400°F)	±0.25°C (±0.45°F)	±0.05% of span	±0.25°C (±0.45°F)
	J3*	-130°C (-202°F)	80°C (176°F)	130°C (266°F)	±0.06°C (±0.10°F)	±0.05% of span	±0.25°C (±0.45°F)
K	K1	-50°C (-58°F)	350°C (662°F)	450°C (842°F)	±0.10°C (±0.18°F)	±0.05% of span	±0.25°C (±0.45°F)
	K2	-50°C (-58°F)	1120°C (2048°F)	1370°C (2498°F)	±0.30°C (±0.54°F)	±0.05% of span	±0.25°C (±0.45°F)
E	E1	-10°C (14°F)	275°C (572°F)	350°C (662°F)	±0.10°C (±0.18°F)	±0.05% of span	±0.25°C (±0.45°F)
	E2	-100°C (-148°F)	800°C (1472°F)	1000°C (1832°F)	±0.25°C (±0.45°F)	±0.05% of span	±0.25°C (±0.45°F)
	E3	-100°C (-148°F)	0°C (32°F)	50°C (122°F)	±0.06°C (±0.10°F)	±0.05% of span	±0.25°C (±0.45°F)
T	T1	-50°C (-58°F)	300°C (572°F)	400°C (752°F)	±0.10°C (±0.18°F)	±0.05% of span	±0.25°C (±0.45°F)
	T2	-100°C (-148°F)	40°C (104°F)	100°C (212°F)	±0.08°C (±0.14°F)	±0.05% of span	±0.25°C (±0.45°F)
	T3*	-190°C (-310°F)	-40°C (-40°F)	50°C (122°F)	±0.12°C (±0.21°F)	±0.05% of span	±0.25°C (±0.45°F)
R	R1	-18°C (0°F)	1310°C (2390°F)	1760°C (3200°F)	±0.60°C (±1.08°F)	±0.05% of span	±0.25°C (±0.45°F)
S	S1	-18°C (0°F)	1310°C (2390°F)	1760°C (3200°F)	±0.50°C (±0.90°F)	±0.05% of span	±0.25°C (±0.45°F)
N	N1	-50°C (-58°F)	950°C (1742°F)	1300°C (2372°F)	±0.40°C (±0.72°F)	±0.05% of span	±0.25°C (±0.45°F)
	N2	-50°C (-58°F)	550°C (1022°F)	700°C (1292°F)	±0.15°C (±0.27°F)	±0.05% of span	±0.25°C (±0.45°F)
B	B1**	200°C (392°F)	1220°C (2228°F)	1820°C (3308°F)	±0.08°C (±0.14°F)	±0.05% of span	±0.25°C (±0.45°F)
No Code	PRG	Specify when input type and range are undetermined or when unit will be stocked as a universal spare (PRG default is J1-0-200°C)					

*SP1 option required for J3 and T3 Range Codes (replace N1 and N2 Range Codes)

**SP2 option required for B1 Range Code (replaces S1 Range Code)

Notes:

1. The TIY output will limit at values which are 5% of maximum span lower than this value and will then display "-LO-".
2. The TIY output will not display values which are 10% of maximum span greater than this value. When exceeded, the display reads "-HI-".
3. Output accuracy is in relation to the unit's calibrated span. See Table 1 and Table 2 for additional span accuracy information.
4. Valid for 400°C and above.

Table 2. Range Limits and Accuracy for the TIY with Millivolt Input

Input Type	Range Code	Lower ¹ (= to 4mA)	Maximum Zero	Upper ² (= to 20mA)	Input	Output ³	Reference Junction Compensation
mV	MV1	-10mV	55mV	75mV	10 microvolts	±0.05% of span	N/A
	MV2	-6mV	17mV	24mV	3.4 microvolts	±0.05% of span	N/A
	MV3	-10mV	3mV	7mV	2 microvolts	±0.05% of span	N/A
No Code	PRG	*SP1 option required for J3 and T3 Range Codes (replace N1 and N2 Range Codes) **SP2 option required for B1 Range Code (replaces S1 Range Code)					

Notes:

1. The TIY output will limit at values which are 5% of maximum span lower than this value and will then display "-LO-".
2. The TIY output will not display values which are 10% of maximum span greater than this value. When exceeded, the display reads "-HI-".
3. Output accuracy is in relation to the unit's calibrated span. See Table 1 and Table 2 for additional span accuracy information.

TIY Model Numbers

To order additional or replacement modules for your system, refer to the Ordering Information table and "build" a model number using the information in bold text. Specify the following in order:

Product / Input Code¹-Calibration Value² F
(Fahrenheit) C (Celsius) or MV (Millivolts) / Output
/ Power / Option(s) [Housing]

¹ Tables 1 and 2 list the range code for the model number Input Code you need for your application.

² Indicates the actual range that you want your TIY calibrated to (must be within the range shown in Tables 1 and 2).

For a TIY, specify:

TIY / J1-0-200 C / 4-20MA / 12-42DC / -ND [HP]

Calibration

Prior to shipment, every TIY is subjected to rigorous testing by our team of skilled technicians. Every product Moore Industries manufactures, sells and services is guaranteed to meet the strict quality standards that have become synonymous with our name.

Before placing your TIY into service, a bench check of basic operation is recommended to ensure that the unit has not sustained any damage during transit, and to set zero and span for your application.

Every unit should be:

- Checked to verify that the appropriate TIY model has been ordered for the intended application.
- Connected in a calibration setup (described later in this section) and checked for desired output.
- Adjusted for desired zero and span.

Even if a unit has been factory calibrated, it is a good idea to perform this calibration as a simple bench check. The procedures provide a safe means of uncovering any unit damage that may have occurred during shipping, and offer a familiarization with TIY operation in the safety of a testing environment, separate from the intended process or application.

These procedures should be carried out in an environment considered appropriate for general testing of electronic equipment, rather than in the field. Use a technician's bench or a similar, lab-type environment.

Setting the Configuration Jumpers

Solderless jumpers are used to configure the TIY's user-selectable operating features.

Figure 1 shows the layout of the configuration jumpers. The layout of the jumpers in the HP- and DIN-style units are identical.

The jumpers for HP-style units are accessed through a removable panel in the rear of the unit. A narrow, slotted-head screwdriver may be used to gently pry the panel off the unit.

Jumpers for DIN-style units are accessed by removing the small, L-shaped panel from the upper right-side of the unit. This panel folds over the top of the unit and is secured with a single screw on top.

A label is affixed on the outside of each unit, below the jumper array, that identifies each jumper (e.g., J301, J302, J303, etc.).

Setting (or installing) a jumper means shorting two adjacent pins together. (Jumpers are provided with each unit.) Figure 1 shows how a jumper is installed and how one is stored when unused.

Table 3 lists the jumper options for configuration jumpers J301 through J305. The remaining jumpers are listed in Table 4. Subsequent paragraphs contain descriptions of the jumpers.

Figure 1. Setting TIY Jumpers

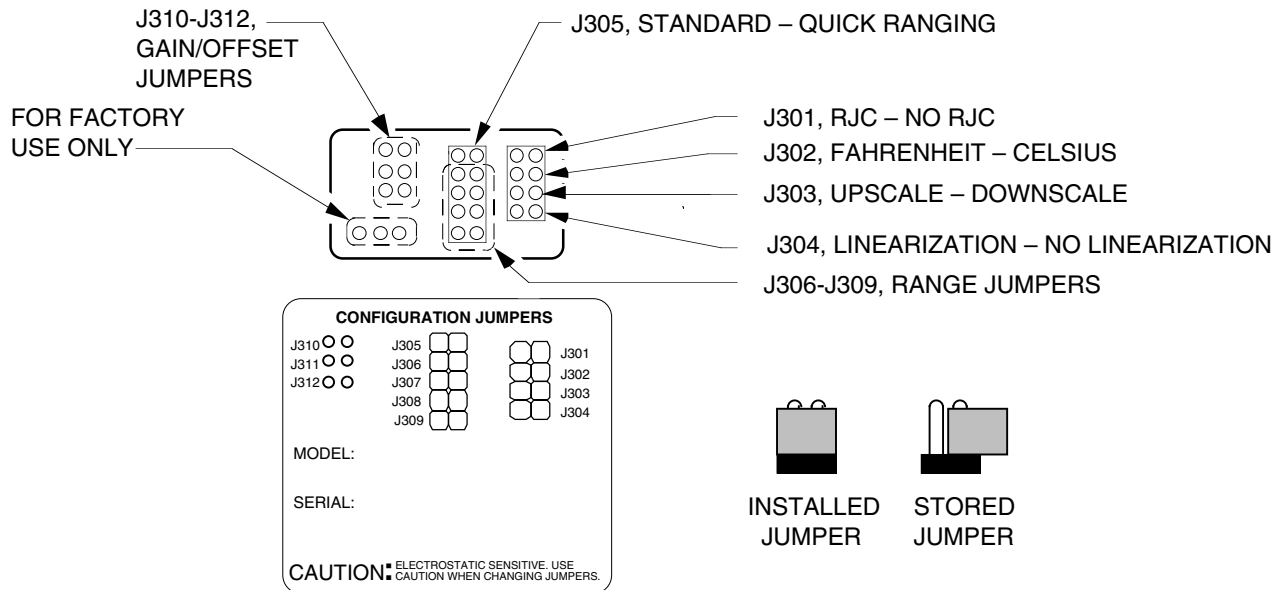

Table 3. Jumper Settings for J301-J305

Jumper	Setting	Result
J301	STORED	RJC Activated
	INSTALLED	RJC Inactive
J302	STORED	Fahrenheit
	INSTALLED	Celcius
J303	STORED	Upscale
	INSTALLED	Downscale
J304	STORED	Linearization
	INSTALLED	No Linearization
J305	STORED	Standard Ranging
	INSTALLED	Quick Ranging

Table 4. Range and Gain/Offset Jumper Settings

Input Code	J306	J307	J308	J309	Gain/Offset Jumper
J1	INSTALLED	INSTALLED	INSTALLED	INSTALLED	J311
J2	INSTALLED	INSTALLED	INSTALLED	STORED	J312
J3*	STORED	INSTALLED	STORED	STORED	J310
K1	INSTALLED	INSTALLED	STORED	INSTALLED	J311
K2	INSTALLED	INSTALLED	STORED	STORED	J312
E1	INSTALLED	STORED	INSTALLED	INSTALLED	J311
E2	INSTALLED	STORED	INSTALLED	STORED	J312
E3	INSTALLED	STORED	STORED	INSTALLED	J310
T1	INSTALLED	STORED	STORED	STORED	J311
T2	STORED	INSTALLED	INSTALLED	INSTALLED	J310
T3*	STORED	STORED	INSTALLED	INSTALLED	J310
R1	STORED	INSTALLED	INSTALLED	STORED	J311
S1	STORED	INSTALLED	STORED	INSTALLED	J311
N1	STORED	INSTALLED	STORED	STORED	J312
N2	STORED	STORED	INSTALLED	INSTALLED	J311
B1**	STORED	INSTALLED	STORED	INSTALLED	J311
MV1	STORED	STORED	INSTALLED	STORED	J312
MV2	STORED	STORED	STORED	INSTALLED	J311
MV3	STORED	STORED	STORED	STORED	J310

*With the SP1 Option, J3 and T3 replaces N1 and N2, respectively.

**With the SP2 Option, B1 replaces S1.

***One jumper from 310-312 must be installed.

The configuration jumpers set the following features:

J301 – Reference Junction Compensation (RJC)

Stored – RJC Activated
Installed – RJC Inactive
This jumper is valid for thermocouple inputs. When J301 is installed (No RJC), the TIY assumes the reference junction to be at zero degrees Celsius (32°F), and allows standard ranging to be accomplished using a millivolt input source and copper wire instead of thermocouple wire.

J302 – Displayed Temperature Type

Stored – Temperature displayed in Fahrenheit
Installed – Temperature displayed in Celsius
If a millivolt range is selected with the Range Jumpers, the LCD displays millivolts and this jumper has no effect

J303 – Burnout

Stored – Upscale Burnout
Installed – Downscale Burnout
This jumper determines the reaction of the TIY output when an error is detected or when the input is open. The output will normally follow the burnout jumper setting.

J304 – Linearization

Stored – Linearization
Installed – No Linearization
This jumper is valid for thermocouple inputs ONLY. When J304 is installed (no linearization), the output is linear with input millivolts, not temperature, and the LCD readings are no longer valid.

J305 – Ranging Method (Calibration)

Stored – Standard Ranging
Installed – Quick Ranging
Standard Ranging requires an input source, an output monitoring device, and power to perform ranging. The push buttons are used to capture the zero and span inputs and trim the zero and full-scale outputs.

Quick Ranging can only be performed on units with LCDs. To set the 4-20 mA output with this ranging method, only power is needed for the unit. The push buttons are used to enter values for zero and span (full-scale).

Note:

Any time a jumper is changed while power is applied, one of the four push buttons must be pressed for the TIY to acknowledge the configuration change.

Calculating the TIY's Accuracy

The output accuracy of the TIY is $\pm 0.05\%$ of span. Accuracy improves for wider spans, and degrades for narrower spans.

Table 5 shows selected narrow, medium, and wide spans for each programmed input code (by thermocouple type). At the top of each column is the accuracy rating for the spans listed in that column.

The accuracy formula shown below is used for calculating the total error for a TIY programmed for the J1 input code (see Table 1) with a wide input span of 300°C (see Table 5).

EXAMPLE:

Input Accuracy + (Span x Output Accuracy) + Cold Junction Compensation Accuracy = Total Error (in degrees)

$$\pm 0.08^{\circ}\text{C} + \pm (300^{\circ}\text{C} \times 0.05\%)^{\circ}\text{C} + \pm 0.25^{\circ}\text{C} = \pm 0.48^{\circ}\text{C}$$

Table 5. Thermocouple Range Input Codes

Input Code	Narrow Input Span* (±0.15%)	Medium Input Span* (±0.075%)	Wide Input Span* (±0.075%)
J1	38-75°C (68-135°F)	75-250°C (135-450°F)	250-500°C (450-900°F)
J2	100-200°C (180-360°F)	200-405°C (360-729°F)	405-810°C (729-1458°F)
J3	25-50°C (45-90°F)	50-130°C (90-234°F)	130-260°C (234-468°F)
K1	50-100°C (90-180°F)	100-250°C (180-450°F)	250-500°C (450-900°F)
K2	125-250°C (225-450°F)	250-710°C (450-1278°F)	710-1420°C (1278-2556°F)
E1	38-75°C (68-135°F)	75-180°C (135-324°F)	180-360°C (324-648°F)
E2	100-200°C (180-360°F)	200-550°C (360-990°F)	550-1100°C (990-1980°F)
E3	25-50°C (45-90°F)	50-75°C (90-135°F)	75-150°C (135-270°F)
T1	50-100°C (90-180°F)	100-225°C (180-405°F)	225-450°C (405-810°F)
T2	30-60°C (54-108°F)	60-100°C (108-180°F)	100-200°C (180-360°F)
T3	45-90°C (81-162°F)	90-120°C (162-216°F)	120-240°C (216-432°F)
R1	225-450°C (405-810°F)	450-890°C (810-1602°F)	890-1778°C (1602-3200°F)
S1	225-450°C (405-810°F)	450-890°C (810-1602°F)	890-1778°C (1602-3200°F)
N1	175-350°C (315-630°F)	350-675°C (630-1215°F)	675-1350°C (1215-2430°F)
N2	75-150°C (135-270°F)	150-375°C (270-675°F)	375-750°C (675-1350°F)
B1	300-600°C (540-1080°F)	600-1620°C (1080-2916°F)	N/A

*Error increases as span decreases

LCD Readings

The LCD on the TIY displays the input readings in degrees Celsius, degrees Fahrenheit, or millivolts.

When the TIY is in any display mode other than Quick Ranging, the LCD displays input values that are electronically rounded to the nearest whole digit; except for mV inputs, which are rounded to the nearest 1/10th of a digit (e.g., 121°C, 1143°F, 56.2mV).

When the TIY is in quick ranging, the values displayed are exact to the least significant digit of the display (e.g. 121.0°C, 1140.0°F, 56.2mV).

Standard and Quick Ranging

Ranging is a method of field calibration. The TIY features two methods of ranging: Standard and Quick. To use either method, configuration jumper J305 must be removed or installed as defined in “Setting the Configuration Jumpers” presented earlier in this section. For jumper setting options (See Figure 1).

TIY

Programmable Isolated
Thermocouple Transmitter

Standard Ranging

Standard ranging is used to set the zero- and 100-percent output settings of the TIY based on user-selected input values. The input values are simulated by calibration equipment to represent actual thermocouple or millivolt input values.

Note:

Standard Ranging is the only field calibration possible for units WITHOUT an LCD. When calibrating a TIY equipped with an LCD, the user should disregard the LCD readings and respond only to the readings of the calibration equipment.

Storing jumper J305 configures the TIY for standard ranging (See Figure 1).

Calibration Setup

Standard Ranging requires an input source, dc power source, and an output meter. Table 6 lists the calibration equipment. Figure 2 illustrates the calibration setup required to perform Standard Ranging.

Caution:

The type of thermocouple wire that will be used in the actual installation must be used during calibration to assure accuracy.

Table 6. Calibration Equipment for Standard Ranging

Equipment	Specifications
Thermocouple Simulator	Accuracy of $\pm 0.02\%$ or better
Voltmeter and Precision Resistor	Digital voltmeter, accuracy of $\pm 0.01\%$ or better, 250 ohm precision resistor, tolerance of $\pm 0.01\%$
DC Power Source	12-42 Vdc; accuracy of $\pm 0.5\%$ or better

Figure 2. Connecting the TIY for Standard Ranging

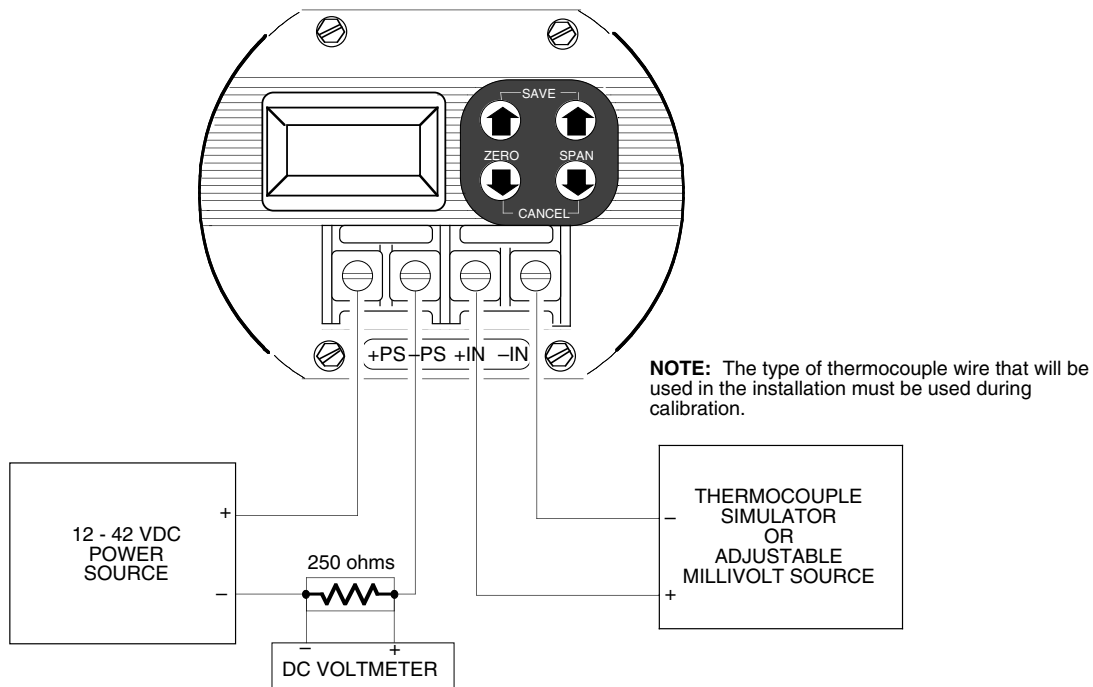

To monitor the output, either a milliammeter or a DC voltmeter with precision load resistor may be used. If the voltmeter and load resistor are chosen, the voltmeter readings will be 1-5 Vdc representing 4-20 mA. Output current reading calculations can be made with the following formula: $V \text{ (voltage reading)}/250 \text{ ohms} = \text{mA}$

Note:

Jumper J305 must be STORED to perform Standard Ranging. Verify its setting, along with other configuration jumpers, before beginning this procedure.

Standard Ranging the TIY

1. Set Range and Gain/Offset Jumpers for the input type (See Table 4).
2. Connect the TIY as shown in Figure 2.
3. To view the current zero setting, press and hold either ZERO push button.

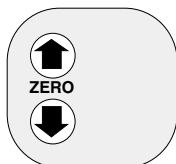

4. To calibrate zero, press both ZERO push buttons simultaneously.

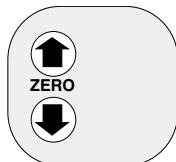

Note:

In Standard Ranging, the LCD will continually flash while calibrating.

5. Set input to the zero temperature value for the configured TIY range (or to the millivolt equivalent as derived from standard thermocouple tables).

6. Simultaneously press both ZERO push buttons twice. This “captures” the applied zero input.

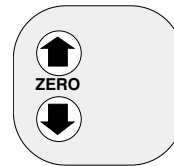

Note:

If the input value being captured exceeds the upper or lower programmed table limits for a particular input type (refer to Tables 1 and 2), the LCD will flash -HI- or -LO-. The input value must be within programmed table limits to be displayed or captured.

7. Verify that the milliammeter or DC voltmeter reads 20 mA (5 Vdc when using voltmeter and load resistor). This indicates that the zero value was captured successfully. Repeat steps 5-7 until the reading is 20 mA.
8. To view current span value, press and hold either SPAN button.

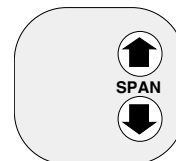

9. To calibrate span, press both SPAN buttons simultaneously.

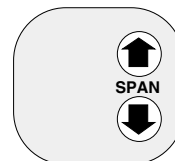

10. Set input to the full scale temperature input for the configured TIY range (or to the millivolt equivalent as derived from standard thermocouple tables). Press both SPAN buttons simultaneously twice to “capture” span.

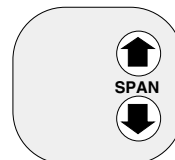

11. Verify that the milliammeter or DC voltmeter indicates 4 mA (1 Vdc when using voltmeter and resistor). This indicates that span was captured successfully. Repeat steps 11 and 12 until the reading is 4 mA.
12. To trim zero-percent output, press one of the ZERO push buttons until the desired output level is indicated on the meter. To set span, continue procedure. Otherwise, go to step 14.

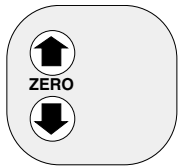

13. To trim span, press either SPAN push button until the desired output level is indicated on the meter.

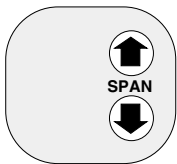

14. When desired values are captured and outputs trimmed, press both Up arrows simultaneously to save the new setting.



Note:

The settings entered during calibration are retained until a subsequent calibration (quick or standard ranging) is performed. If the latest settings are not saved before removing power, or if the CANCEL push buttons are pressed simultaneously, the unit will revert to the last saved values.

15. Check zero and full-scale settings by inputting zero and full scale, and monitoring the effect on TIY output.

16. Disconnect calibration equipment. If you used a millivolt source to calibrate the unit, remove (store) jumper J301 (enable RJC) before placing the calibrated unit into service. If you will need to perform any subsequent quick ranging, install J305 (units with -ND option (no display) cannot be quick ranged).

Quick Ranging

Quick Ranging allows the user to calibrate the standard TIY without an input source or output monitoring device.

After installing J305 (see Figure 1), a 12-42 Vdc power source applied to the +PS and -PS terminals of the TIY is all that is required to perform Quick Ranging. The push buttons are used to set zero and span values. The user-selected values are displayed on the unit's LCD.

When quick ranging is selected, the TIY ignores signals to the input terminals (+IN and -IN). The zero-percent output will be 4 mA for whatever value zero is set to with the ZERO push buttons, and the 100-percent output will be 20 mA for whatever the full-scale value is set to with the SPAN push buttons.

Figure 3 illustrates the DC power hookup required to perform quick ranging of the TIY.

Note:

Jumper J305 must be INSTALLED to perform quick ranging. Verify its setting, along with other configuration jumpers, before beginning this procedure (See Figure 1 and Table 3).

Figure 3. Connecting the TIY for Quick Ranging

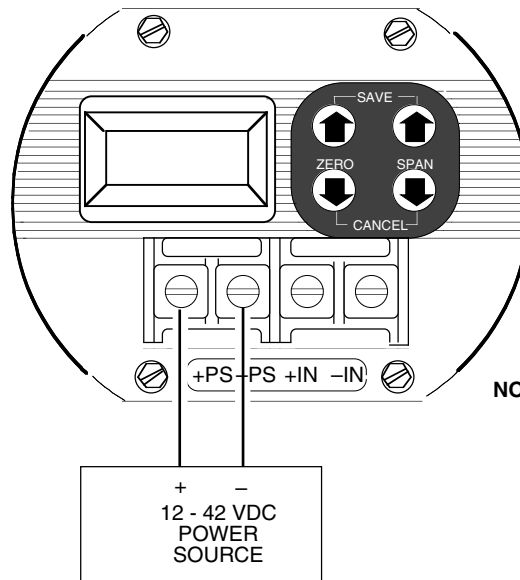

NOTE: 1. -ND units cannot perform quick ranging.
2. Input is ignored when the unit is configured for quick ranging.

Quick Ranging the TIY

To calibrate the TIY using Quick Ranging:

1. Set Range and Gain/Offset Jumpers for the input type (See Table 4).
2. Apply DC power to the TIY as shown in Figure 3.
3. Press and hold either ZERO push button. Note the zero value displayed.

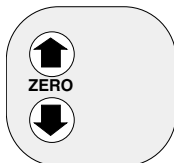

4. To change the zero setting, press both ZERO push buttons simultaneously.

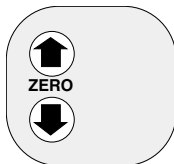

Note:

If the display begins to flash after pressing both push buttons simultaneously, the TIY is configured for Standard Ranging. Check J305 (See Figure 1 and Table 3).

5. Set zero shown on LCD to desired setting using the Up or Down ZERO push button to increment or decrement the displayed value.

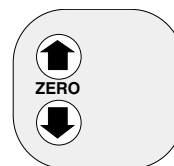

Note:

When the value entered exceeds the upper or lower programmed table limits for a particular input, the LCD will display -HI- or -LO-, respectively. The value entered must be within programmed table limits to be displayed (See Table 1).

TIY

Programmable Isolated
Thermocouple Transmitter

6. Press and hold either SPAN push button to display the span (full scale) value.

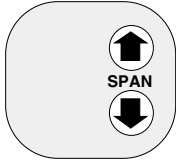

7. To change span setting, press both SPAN push buttons simultaneously.

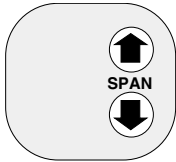

Note:

If the display begins to flash after pressing the Up and Down push buttons simultaneously, the TIY is configured for Standard Ranging. Check J305 (See Figure 1 and Table 3).

8. Set the span shown on LCD to desired setting using either SPAN push button to increment or decrement the displayed value.

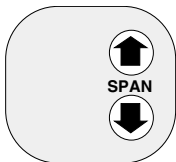

9. When the desired 100-percent input value is obtained, press both Up arrows simultaneously to save the new span (full-scale) and zero setting.



Note:

The TIY will take a moment to store the new value and reset itself. It will return to the operate mode and display the currently applied input value.

10. Press either ZERO push button to verify the zero setting.

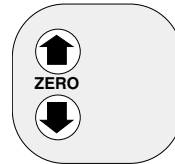

Note:

If the zero input value is incremented too close to the full-scale input setting, the full-scale setting will automatically increase to the upper table limit for the input type for which the unit is configured. If the full-scale value is decremented too close to the zero input setting, the zero setting will automatically decrease to the lower table limit. The input type is set with the Range Jumpers. The upper and lower limits can be found in Table 1.

11. Press either SPAN push button to verify the full-scale setting.

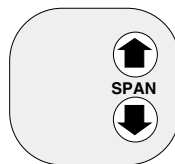

12. Remove DC power, quick ranging is complete.

Note:

Although the TIY may remain configured for quick ranging, you may wish to store J305 (standard ranging) before placing the unit into service. This allows the unit's outputs to be trimmed without changing jumpers after the unit is installed. It also prevents inadvertent changes to the input settings, which can easily occur in quick ranging.

Installation

Installing the TIY consists of physically mounting the unit and completing the electrical connections. The following sections describe these tasks.

Mounting the TIY

The TIY is available in an HP- or DIN-style housing. Physical mounting requirements differ for each housing style.

The HP Housing. Figure 4 is an outline dimensional drawing of the HP-style unit with the FL housing option. The spring clips on standard HP-style units (not shown) have no dimensional significance.

The spring clips on HP-style units hold the unit in place when mounted in explosion-proof enclosures. The spring clips are squeezed inward to allow for positioning of the unit in the base of the explosion-proof enclosure. When released, they recoil to an extended position slightly over the outer edge of the unit, providing adequate pressure to hold the unit in the enclosure.

The DIN-style Housing. Figure 5 is an outline dimensional drawing of the DIN-style TIY. DIN-style units mount directly onto standard G-type (DIN EN50035) and Top Hat (DIN EN50022) rails. This packaging is ideal for high-density mounting of DIN-style packages on one common DIN rail.

Figure 4. Dimensions of the TIY in HP Housing

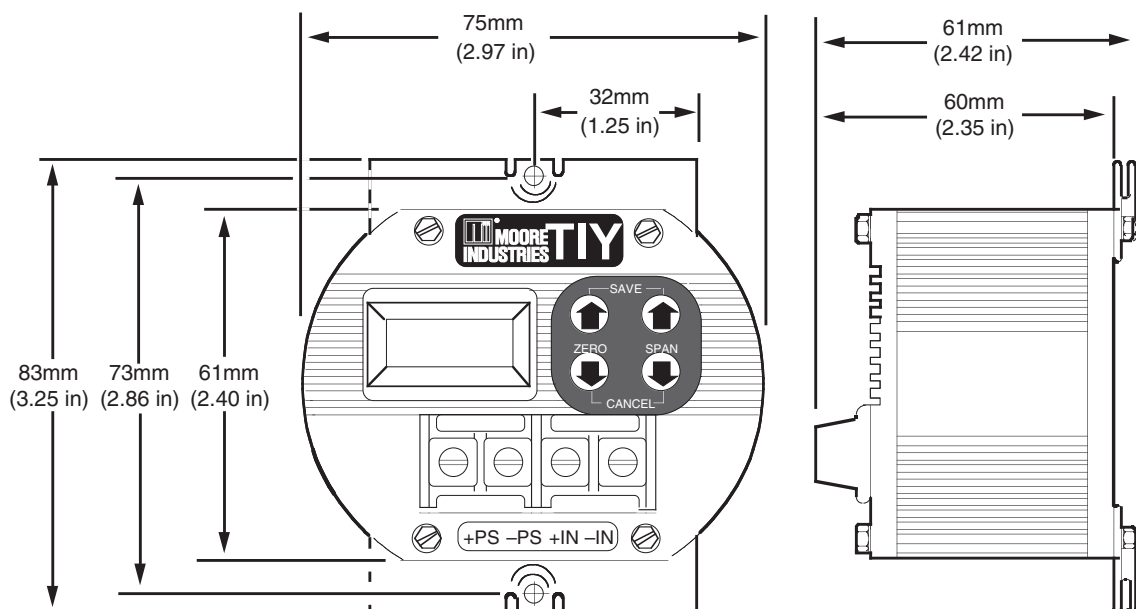
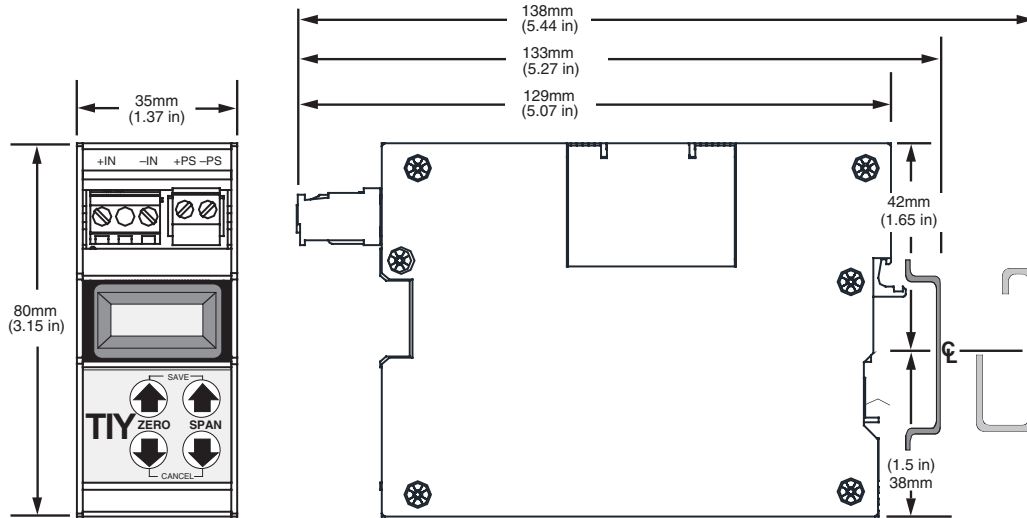

Figure 5. Dimensions of the TIY in DIN Housing



Making the Electrical Connections

The TIY is a loop-powered instrument. The terminals for the power connections are marked “+PS” and “-PS”. The input connections are marked “+IN” and “-IN”.

When the input to the TIY is a thermocouple (T/C), thermocouple wire must be used for the input connections. If the input is other than a thermocouple, thermocouple wire is not required.

Figure 6 is a typical installation hookup diagram of the TIY. Note the polarity of the wiring connections.

Recommended Ground Wiring Practices

Moore Industries recommends the following ground wiring practices:

- Any Moore Industries product in a metal case or housing should be grounded.
- The protective earth conductor must be connected to a system safety earth ground before making other connections.
- All input signals to, and output signals from, Moore Industries’ products should be wired using a shielded, twisted pair wiring technique. Shields should be connected to an earth or safety ground.

- For the best shielding, the shield should be run all the way from the signal source to the receiving device. (see Note below)
- The maximum length of un-shielded input and output signal wiring should be 2 inches.

Note: Some of Moore Industries’ instruments can be classified as receivers (IPT², IPX², etc.) and some can be classified as transmitters (TRX, TRY, etc.) while some are both a receiver and a transmitter (SPA², HIM, etc). Hence, your shield ground connections should be appropriate for the type of signal line being shielded. The shield should be grounded at the receiver and not at the signal source.

CE Conformity

Installation of any Moore Industries products that carry the CE certification (Commission Electrotechnique) must adhere to the guidelines above in order to meet the requirements set forth in applicable EMC (Electromagnetic Compatibility) directive 2004/108/EC and specifications laid out in EMC requirement EN 61326-1:2006 electrical equipment for measurement, control and laboratory use.

Consult the factory for the most current information on products that have been CE certified.

Figure 6. Installing the TIY

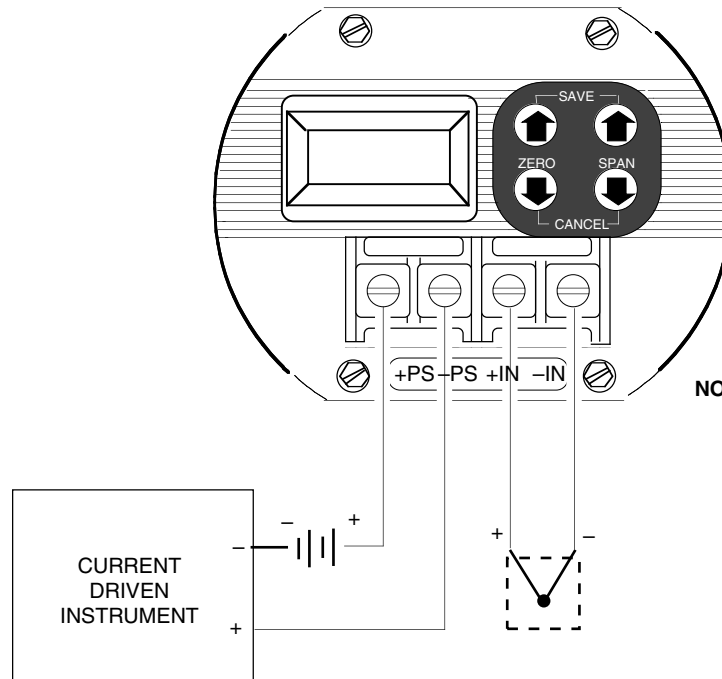

- NOTE:**
1. The TIY accepts either a thermocouple or millivolt input.
 2. If a thermocouple input is used, thermocouple wire of the same type must be used.

Operation

Operating the TIY is limited to viewing the LCD for input values, zero or span reading, or problem codes; and performing quick ranging using the push buttons. Units without an LCD have no definitive operating procedures.

When a non-LCD unit is calibrated with standard ranging methods, it can reliably be installed in a process system, but must be removed to perform subsequent calibrations.

The LCD

During normal operation, the LCD typically displays the applied input value. As the input changes, the readout of the LCD changes accordingly.

The LCD also displays problem codes resulting from the TIY's self-diagnostics. Codes indicate malfunctions or discrepancies detected by the TIY's micro-processor at power-up, during calibration, or in the operate mode. Table 7 contains these codes, the problem indicated, and the remedy for each.

Table 7. Self-diagnostic Problem Codes

Code	Problem	Remedy
P1	Failed RAM test on power up	Cycle DC power; if the problem persists, return unit per instructions on the back cover of this manual
P2	Failed ROM checksum on power up	
P3	Failed EEPROM checksum on power up	If power is lost during calibration, repeat calibration; otherwise, cycle DC power; if the problem persists, return unit per instructions on the back cover of this manual
P4	EPROM did not write properly	Cycle DC power; if the problem persists, return unit per instructions on the back cover of this manual
P5	Bad RJC circuit	

Maintenance

The TIY is designed to operate reliably with a minimum of field maintenance.

Field maintenance is limited to keeping the unit clean and the wire terminals free of oxidation. Periodic visual inspections should be performed to ensure the unit is clean and the electrical connections are in good repair. The frequency of these inspections is based on the environment in which the unit is operated.

If the TIY is mounted in an explosion-proof enclosure, the unit will remain cleaner for a longer period of time than if it is directly exposed to environmental elements.

To perform a thorough calibration of the TIY, the unit must be removed from the system and checked out using standard ranging methods.

Customer Support

Moore Industries is recognized as the industry leader in delivering top quality to its customers in products and services. We perform a battery of stringent quality assurance checks on every unit we ship. If any Moore Industries product fails to perform up to rated specifications, call us for help. Our highly skilled staff of trained technicians and engineers pride themselves on their ability to provide timely, accurate, and practical answers to your process instrumentation questions. Factory phone numbers are on the back cover.

If problems involve a particular TIY, there are several pieces of information you can gather before you call the factory that will help our staff get you answers more efficiently. When you call, please have:

- The model number of the unit in question.
- The serial number of the unit in question.
- The job number (if available).
- The purchase order under which the unit was shipped (if available).

Appendix A: Intrinsic Safety

This page contains the installation diagram for the TIY carrying the intrinsically safe option. It also includes guidelines for setting up zener barriers necessary in these types of applications.

This diagram must be used to augment the installation instructions earlier in this manual for units that are to operate in areas requiring intrinsically safe instrumentation.

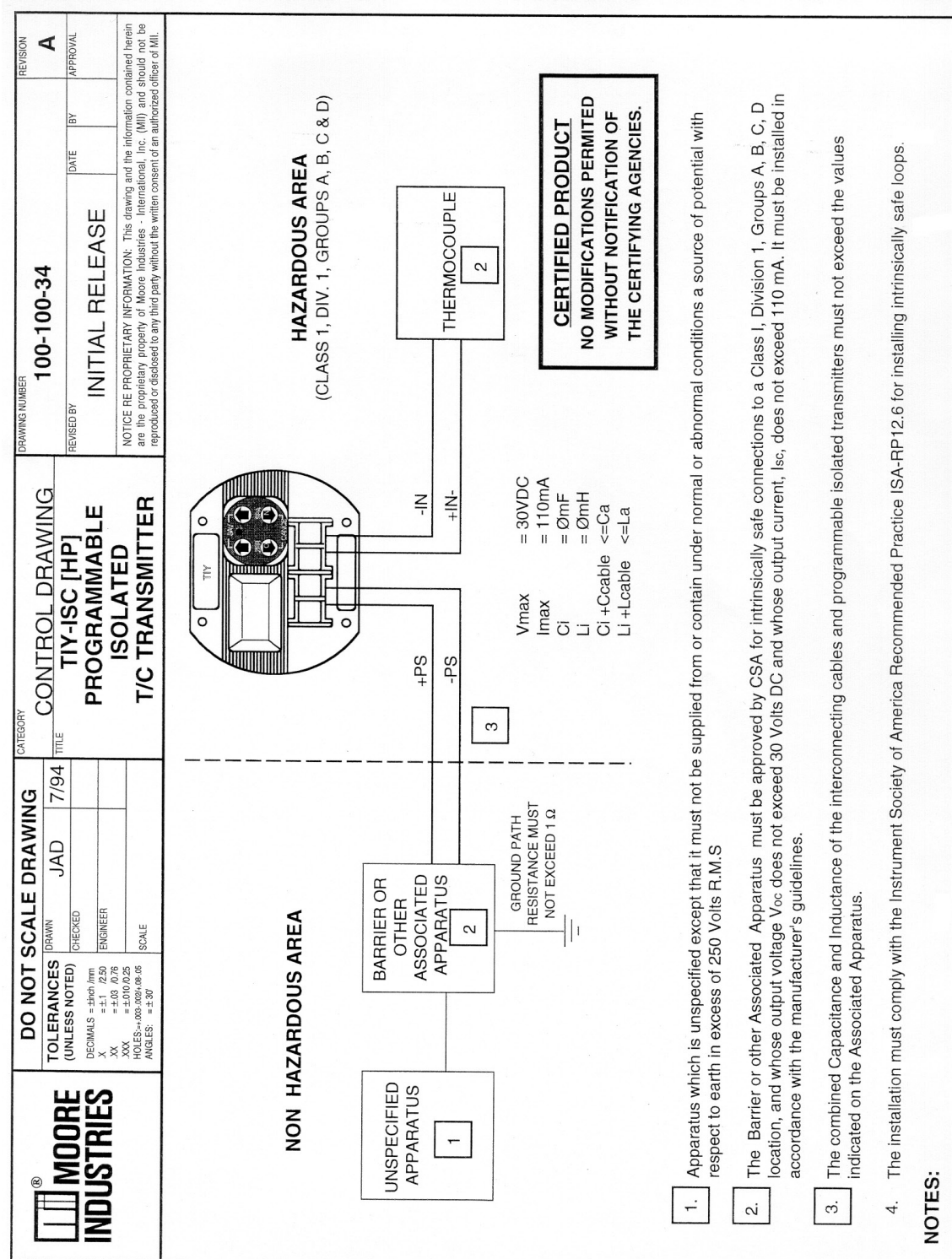

RETURN PROCEDURES

To return equipment to Moore Industries for repair, follow these four steps:

1. Call Moore Industries and request a Returned Material Authorization (RMA) number.

Warranty Repair –

If you are unsure if your unit is still under warranty, we can use the unit's serial number to verify the warranty status for you over the phone. Be sure to include the RMA number on all documentation.

Non-Warranty Repair –

If your unit is out of warranty, be prepared to give us a Purchase Order number when you call. In most cases, we will be able to quote you the repair costs at that time. The repair price you are quoted will be a "Not To Exceed" price, which means that the actual repair costs may be less than the quote. Be sure to include the RMA number on all documentation.

2. Provide us with the following documentation:
 - a) A note listing the symptoms that indicate the unit needs repair
 - b) Complete shipping information for return of the equipment after repair
 - c) The name and phone number of the person to contact if questions arise at the factory
3. Use sufficient packing material and carefully pack the equipment in a sturdy shipping container.
4. Ship the equipment to the Moore Industries location nearest you.

The returned equipment will be inspected and tested at the factory. A Moore Industries representative will contact the person designated on your documentation if more information is needed. The repaired equipment, or its replacement, will be returned to you in accordance with the shipping instructions furnished in your documentation.

WARRANTY DISCLAIMER

THE COMPANY MAKES NO EXPRESS, IMPLIED OR STATUTORY WARRANTIES (INCLUDING ANY WARRANTY OF MERCHANTABILITY OR OF FITNESS FOR A PARTICULAR PURPOSE) WITH RESPECT TO ANY GOODS OR SERVICES SOLD BY THE COMPANY. THE COMPANY DISCLAIMS ALL WARRANTIES ARISING FROM ANY COURSE OF DEALING OR TRADE USAGE, AND ANY BUYER OF GOODS OR SERVICES FROM THE COMPANY ACKNOWLEDGES THAT THERE ARE NO WARRANTIES IMPLIED BY CUSTOM OR USAGE IN THE TRADE OF THE BUYER AND OF THE COMPANY, AND THAT ANY PRIOR DEALINGS OF THE BUYER WITH THE COMPANY DO NOT IMPLY THAT THE COMPANY WARRANTS THE GOODS OR SERVICES IN ANY WAY.

ANY BUYER OF GOODS OR SERVICES FROM THE COMPANY AGREES WITH THE COMPANY THAT THE SOLE AND EXCLUSIVE REMEDIES FOR BREACH OF ANY WARRANTY CONCERNING THE GOODS OR SERVICES SHALL BE FOR THE COMPANY, AT ITS OPTION, TO REPAIR OR REPLACE THE GOODS OR SERVICES OR REFUND THE PURCHASE PRICE. THE COMPANY SHALL IN NO EVENT BE LIABLE FOR ANY CONSEQUENTIAL OR INCIDENTAL DAMAGES EVEN IF THE COMPANY FAILS IN ANY ATTEMPT TO REMEDY DEFECTS IN THE GOODS OR SERVICES, BUT IN SUCH CASE THE BUYER SHALL BE ENTITLED TO NO MORE THAN A REFUND OF ALL MONIES PAID TO THE COMPANY BY THE BUYER FOR PURCHASE OF THE GOODS OR SERVICES.

ANY CAUSE OF ACTION FOR BREACH OF ANY WARRANTY BY THE COMPANY SHALL BE BARRED UNLESS THE COMPANY RECEIVES FROM THE BUYER A WRITTEN NOTICE OF THE ALLEGED DEFECT OR BREACH WITHIN TEN DAYS FROM THE EARLIEST DATE ON WHICH THE BUYER COULD REASONABLY HAVE DISCOVERED THE ALLEGED DEFECT OR BREACH, AND NO ACTION FOR THE BREACH OF ANY WARRANTY SHALL BE COMMENCED BY THE BUYER ANY LATER THAN TWELVE MONTHS FROM THE EARLIEST DATE ON WHICH THE BUYER COULD REASONABLY HAVE DISCOVERED THE ALLEGED DEFECT OR BREACH.

RETURN POLICY

For a period of thirty-six (36) months from the date of shipment, and under normal conditions of use and service, Moore Industries ("The Company") will at its option replace, repair or refund the purchase price for any of its manufactured products found, upon return to the Company (transportation charges prepaid and otherwise in accordance with the return procedures established by The Company), to be defective in material or workmanship. This policy extends to the original Buyer only and not to Buyer's customers or the users of Buyer's products, unless Buyer is an engineering contractor in which case the policy shall extend to Buyer's immediate customer only. This policy shall not apply if the product has been subject to alteration, misuse, accident, neglect or improper application, installation, or operation. THE COMPANY SHALL IN NO EVENT BE LIABLE FOR ANY INCIDENTAL OR CONSEQUENTIAL DAMAGES.



WORLDWIDE • www.miinet.com

United States • info@miinet.com
Tel: (818) 894-7111 • FAX: (818) 891-2816

Australia • sales@mooreind.com.au
Tel: (02) 8536-7200 • FAX: (02) 9525-7296

Belgium • info@mooreind.be
Tel: 03/448.10.18 • FAX: 03/440.17.97

The Netherlands • sales@mooreind.nl
Tel: (0)344-617971 • FAX: (0)344-615920

China • sales@mooreind.sh.cn
Tel: 86-21-62491499 • FAX: 86-21-62490635

United Kingdom • sales@mooreind.com
Tel: 01293 514488 • FAX: 01293 536852